

Bird Box Upgrade Kit

Compatible with Wingspan
Oceania Expansion

This product is not licensed and is up for change at any time in the future.



Assembly Guide

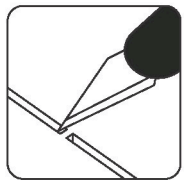

Use an exacto knife to cut the bits connecting the parts to the frame.

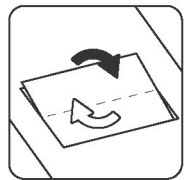

Remove the parts from the frame with a rotating motion along the axis formed by the bits you just cut.

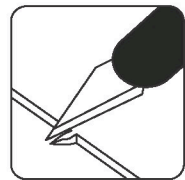

Use the exacto knife to remove any of the remaining connection bits.

Use **wood glue** for assembly. Always dry fit the parts first to make sure the components are correct ones. If you encounter any issues, please contact us at info@laserox.net or our Facebook page at facebook.com/laseroxinserts.

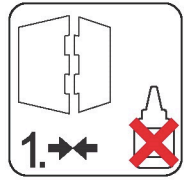

Always dry-fit the parts to together without any glue to make sure you are assembling the correct parts.



Use a drop of glue along the joints and hold it in place until the glue has sufficiently dried.

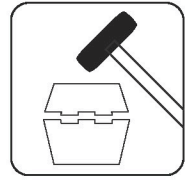

Press the parts together or use a hobby hammer with slight force for assembly.



14+ **WARNING** Choking hazard!
Not for children under 14 years.

Part numbers

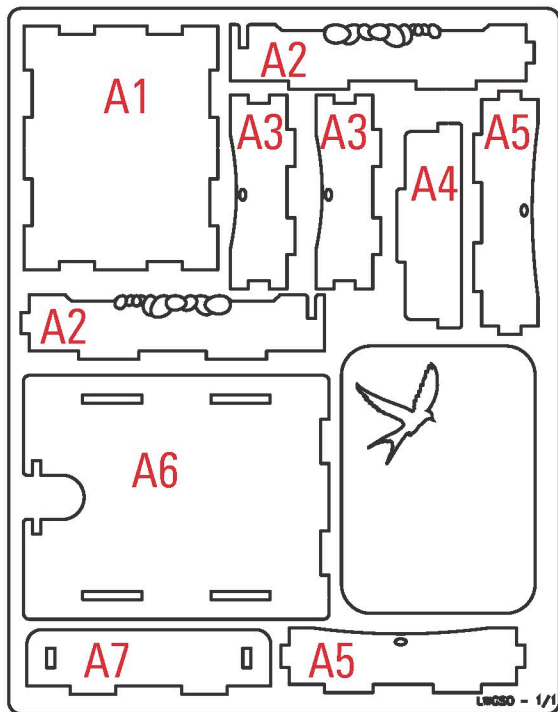

Card tray

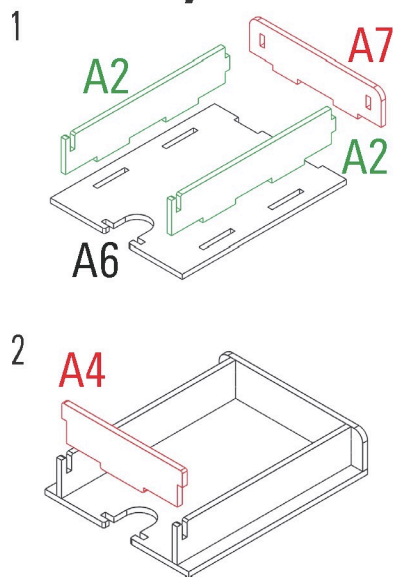

Token tray

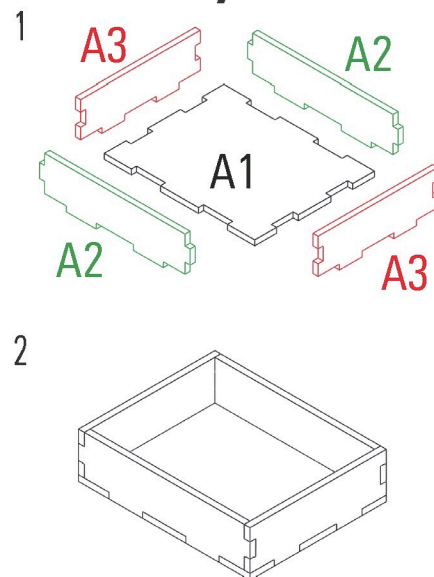

Assembly

Use A8 to separate Solo Cards and Scora Cards.

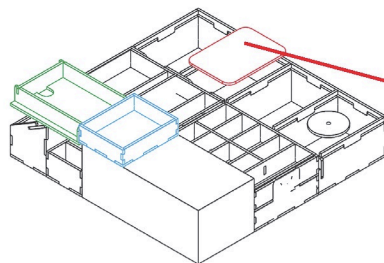

LASEROX



Laserox Design Ltd.
H-2092 Budakeszi
Tiefenweg way 39

