

Terraformer's Toolbox

LTFM

Compatible with Terraforming Mars®



Assembly Guide

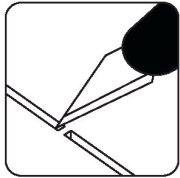

Use an exacto knife to cut the bits connecting the parts to the frame.

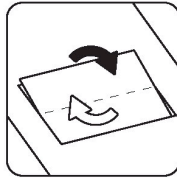

Remove the parts from the frame with a rotating motion along the axis formed by the bits you just cut.

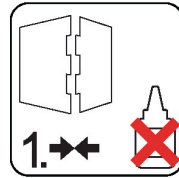

Always dry-fit the parts to together without any glue to make sure you are assembling the correct parts.



Use a drop of glue along the joints and hold it in place until the glue has sufficiently dried.

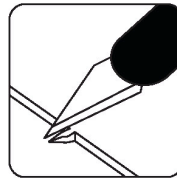

Use the exacto knife to remove any of the remaining connection bits.

Use **wood glue** for assembly. Always dry fit the parts first to make sure the components are correct ones. If you encounter any issues, please contact us at info@laserox.net or our Facebook page at facebook.com/laseroxinserts.



LASEROX

This box organizer is compatible with Terraforming Mars®. This product is not licensed, and is up for change at any time in the future.



WARNING: Choking hazard! Not for children under 14 years.

Part numbers

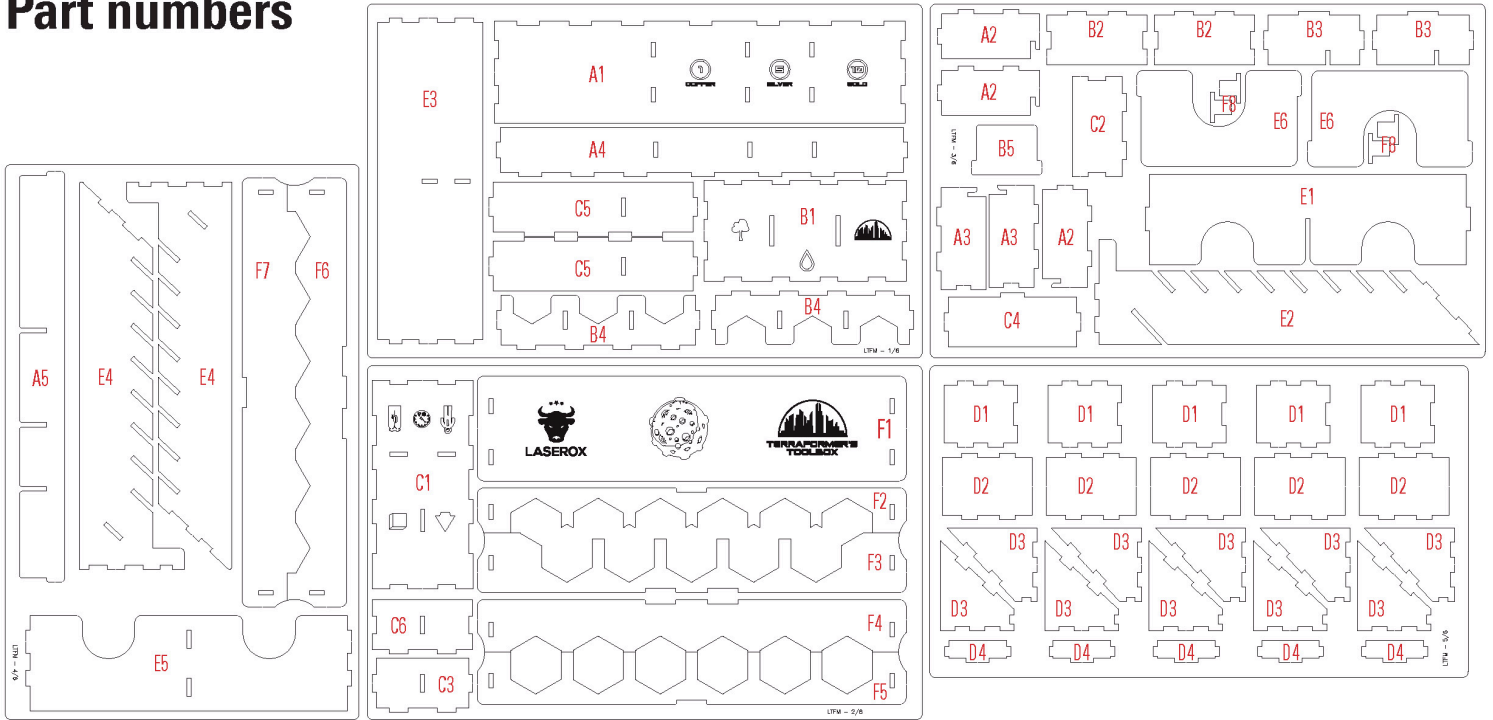

Part 1. Metal Cubes

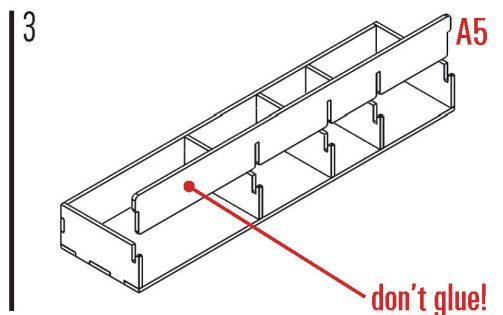
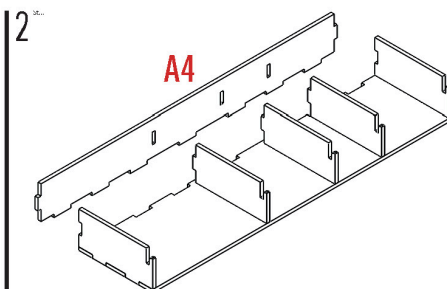
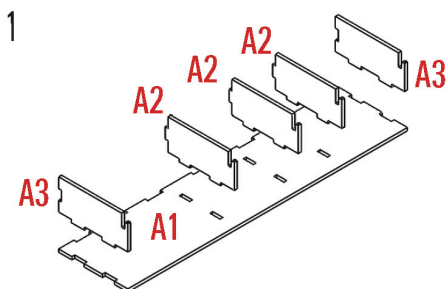

Required parts: **A1, A2x3, A3x2, A4, A5**

Part 2. Hex Tiles

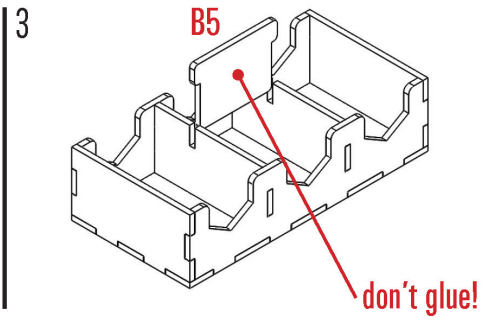
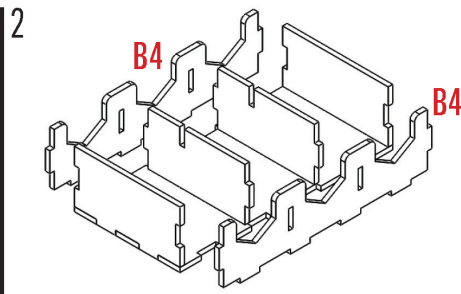
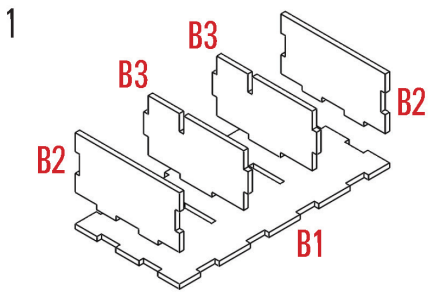

Required parts: **B1, B2x2, B3x2, B4, B5**

Part 3. Bit Box

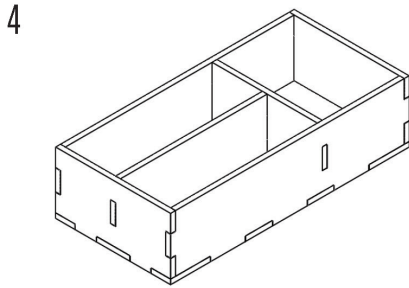
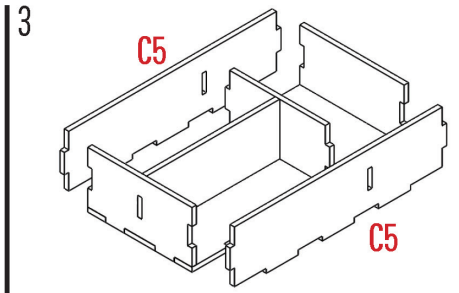
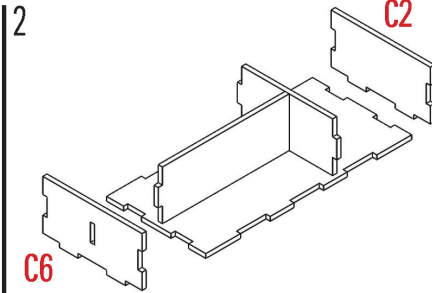
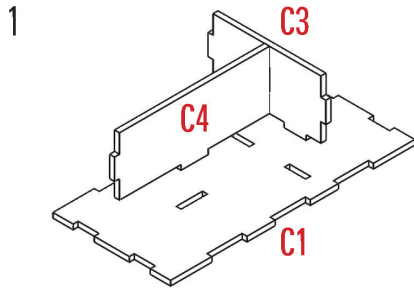

Required parts: **C1, C2, C3, C4, C5x2, C6**

Part 4. Cubes

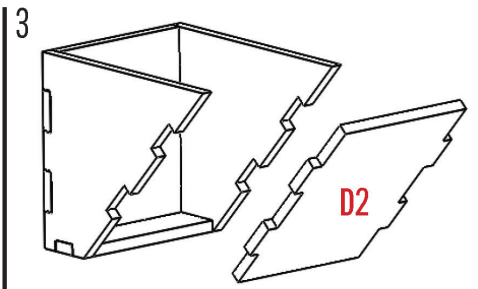
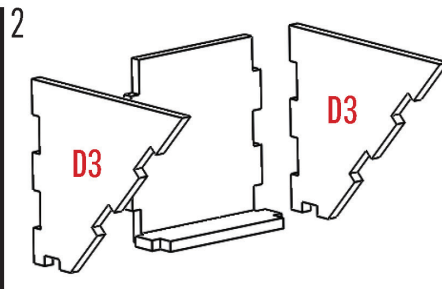
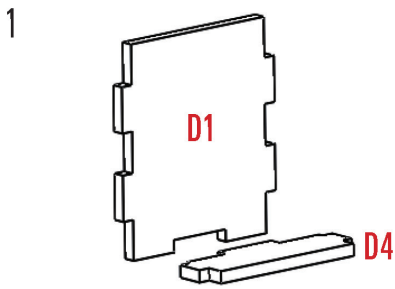

Required parts: **D1, D2, D3x2, D4**

Part 6. Achievements

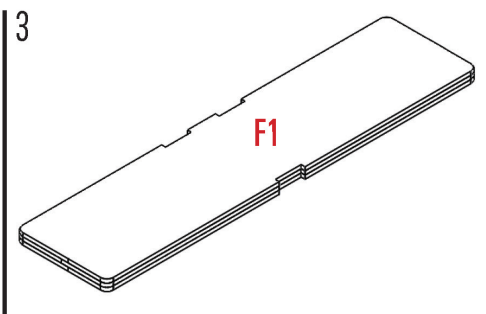
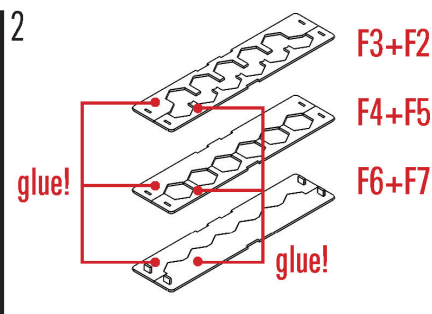
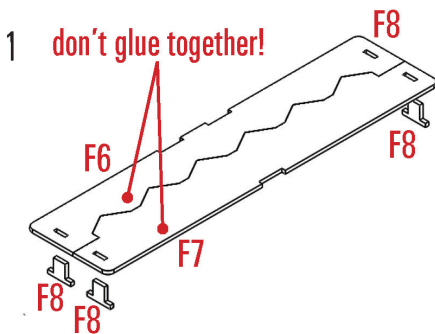

Required parts: **F1, F2, F3, F4, F5, F6, F7, F8x4,**

Part 5. Card Tray

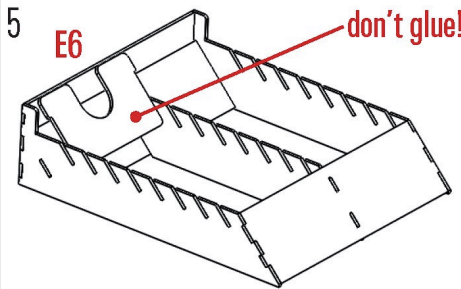
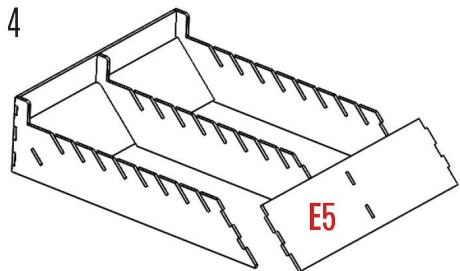
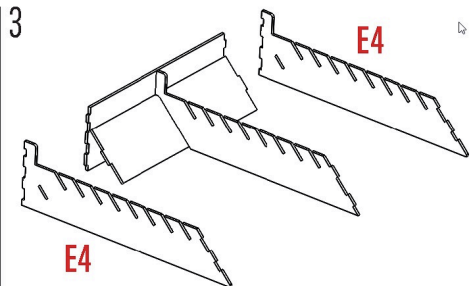
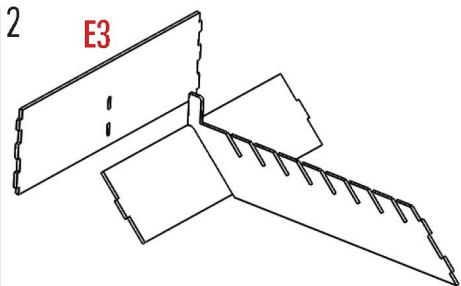
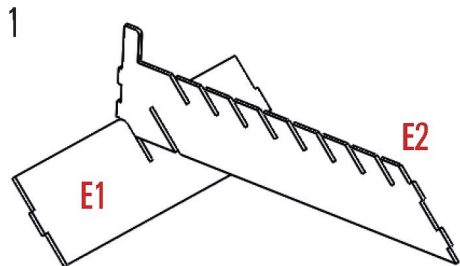

Required parts: **E1, E2, E3, E4x2, E5, E6x8** (optional)

Box Assembly

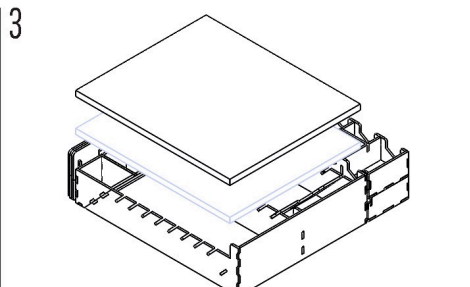
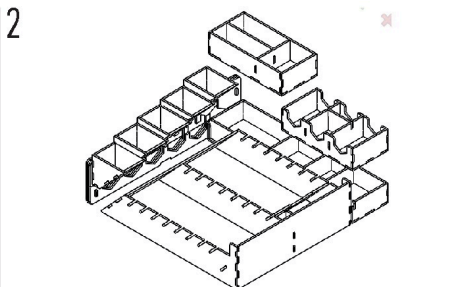
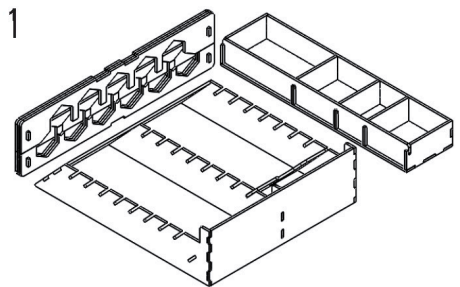

We would like to extend our offer to you:



Game Meter

Emotinsert

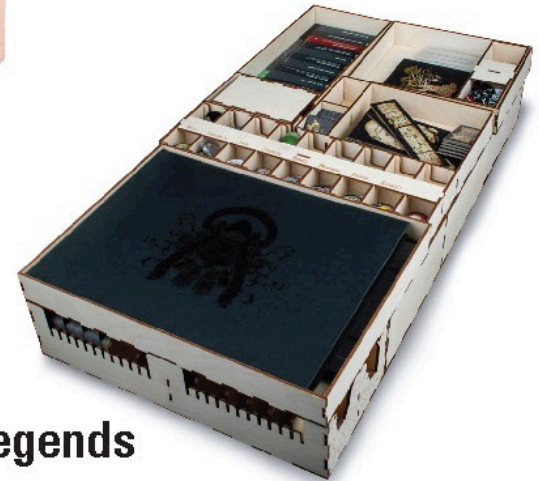

Lantern's Legends



Laserox Design Ltd.
H-2092 Budakeszi
Tiefenweg 39

