

Spirit Crate

LSIDBB

Compatible with Spirit Island and expansions

This box organizer is compatible with Spirit Island, but does not include our two organizers. This product is not licensed, and is up for change at any time in the future.



Assembly Guide



Watch our beginners guide videos on youtube. Just scan the QR code and get started!

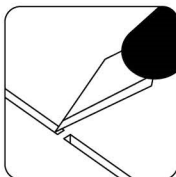

Use an exacto knife to cut the bits connecting the parts to the frame.

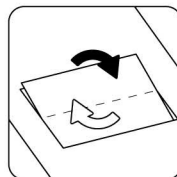

Remove the parts from the frame with a rotating motion along the axis formed by the bits you just cut.

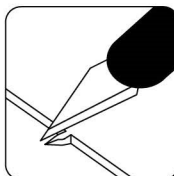

Use the exacto knife to remove any of the remaining connection bits.

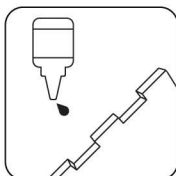

Most joints are press-fit, but some joints might require a drop of glue to ensure a strong bond.

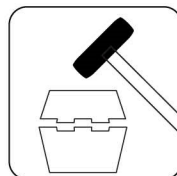

Press the parts together or use a hobby hammer with slight force for assembly.



LASEROX

Use **wood glue** for assembly. If you encounter any issues, please contact us at info@laserox.net



WARNING: Not a toy. Not suitable for children under 14 years of age.

Box Assembly

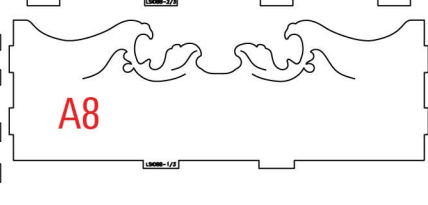
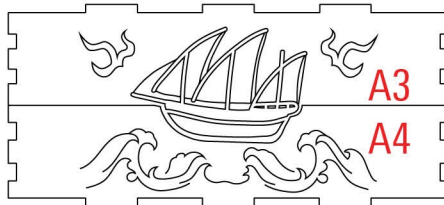
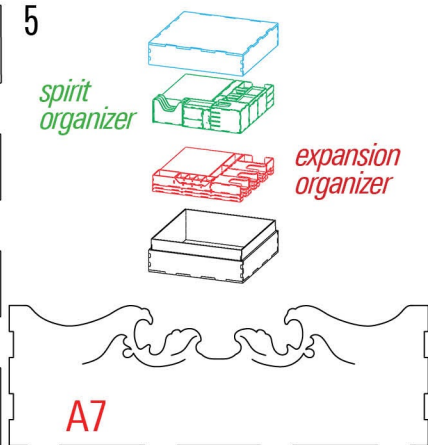
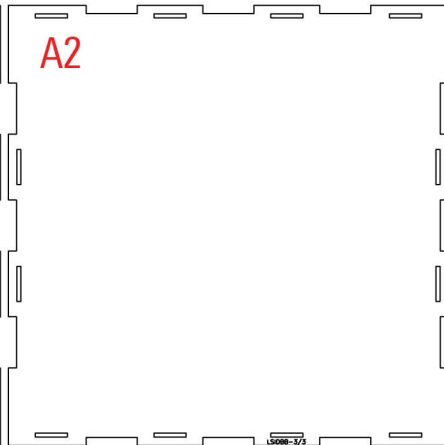
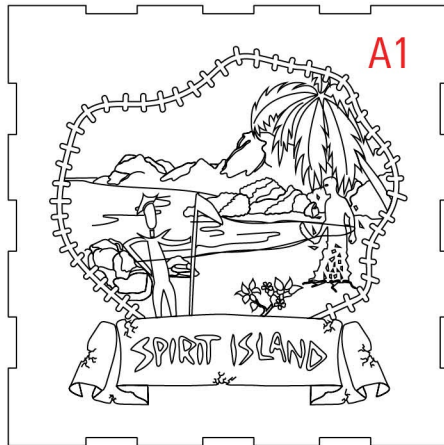
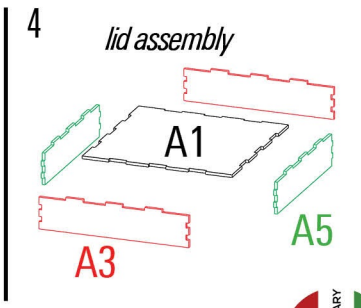
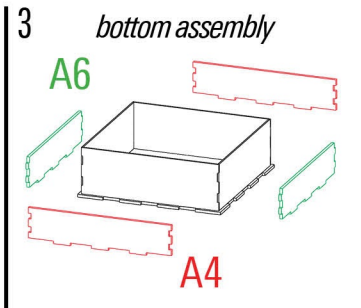
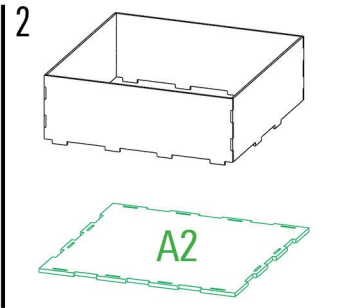
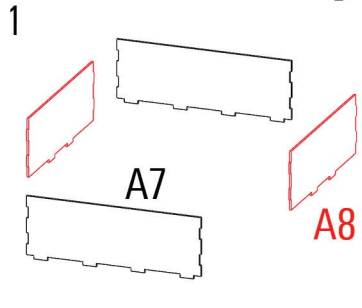

Laserox Design Ltd.
H-2092 Budakeszi
Tiefenweg way 39

