

Sentinels of the Multiverse: Definitive Edition Organizer

Compatible with Sentinels of the Multiverse: Definitive Edition

This box organizer is compatible with Sentinels of the Multiverse: Definitive Edition. This product is not licensed, and is up for change at any time in the future.



Assembly Guide



Watch our beginners guide videos on youtube. Just scan the QR code and get started!

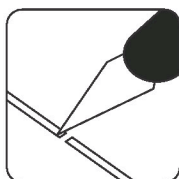

Use an exacto knife to cut the bits connecting the parts to the frame.

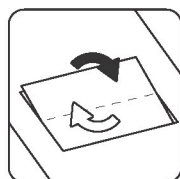

Remove the parts from the frame with a rotating motion along the axis formed by the bits you just cut.

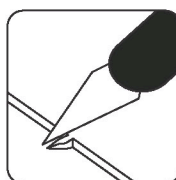

Use the exacto knife to remove any of the remaining connection bits.

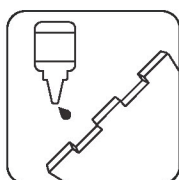

Most joints are press-fit, but some joints might require a drop of glue to ensure a strong bond.

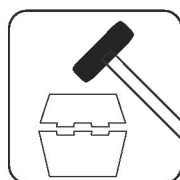

Press the parts together or use a hobby hammer with slight force for assembly.



LASEROX

Use wood glue for assembly. If you encounter any issues, please contact us at info@laserox.net



WARNING: Not a toy. Not suitable for children under 14 years of age.

Box Assembly

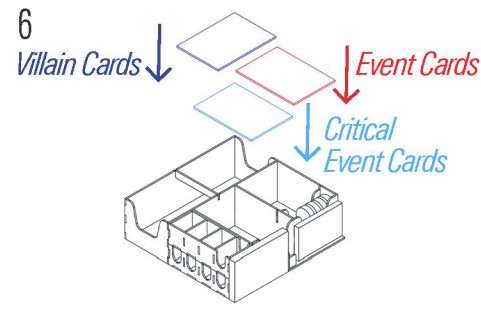
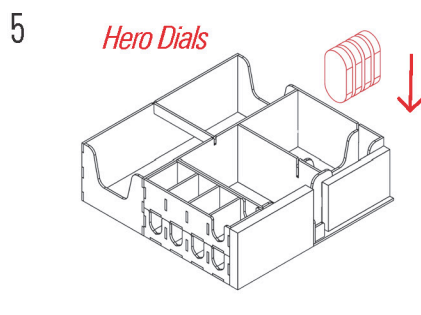
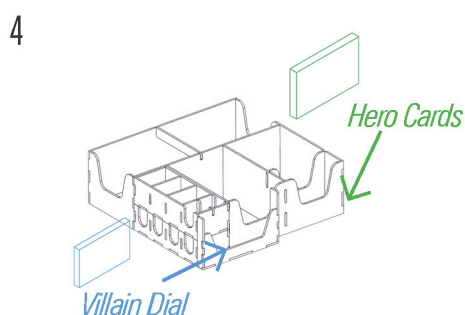
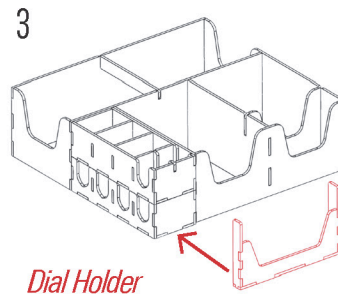
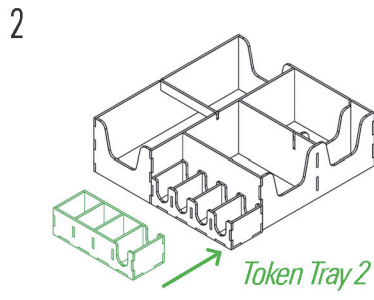
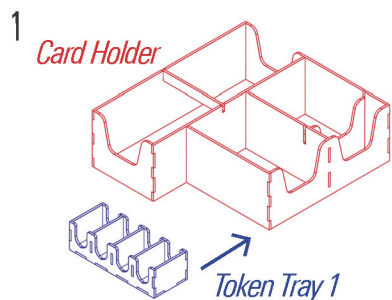

Share your creation!



#laseroxinserts

Watch our "How it fits" video and get your game organized!



<http://tiny.cc/lsrxlsen>

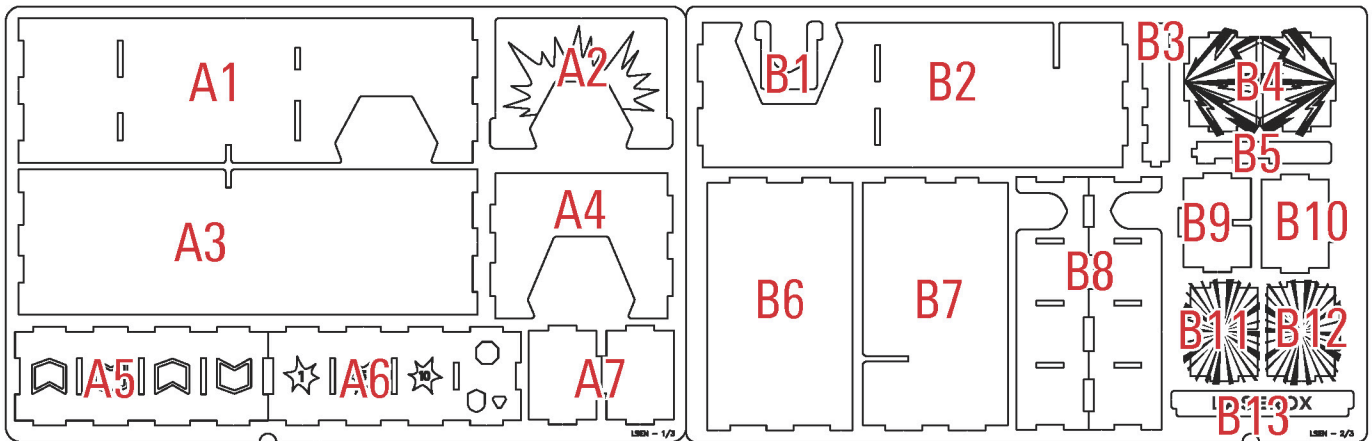

- Some parts might look different than in the assembly instructions, with added decorations/engravings/embellishments.
- Color variations or branch marks are a natural part of the birch plywood.
- The burnt smell of wood is natural and will dissipate with time.
- Rarely the laser will not cut through the complete sheet, but this can be fixed with the help of a hobby knife. If that is not possible, please contact us for a replacement!

Card Holder

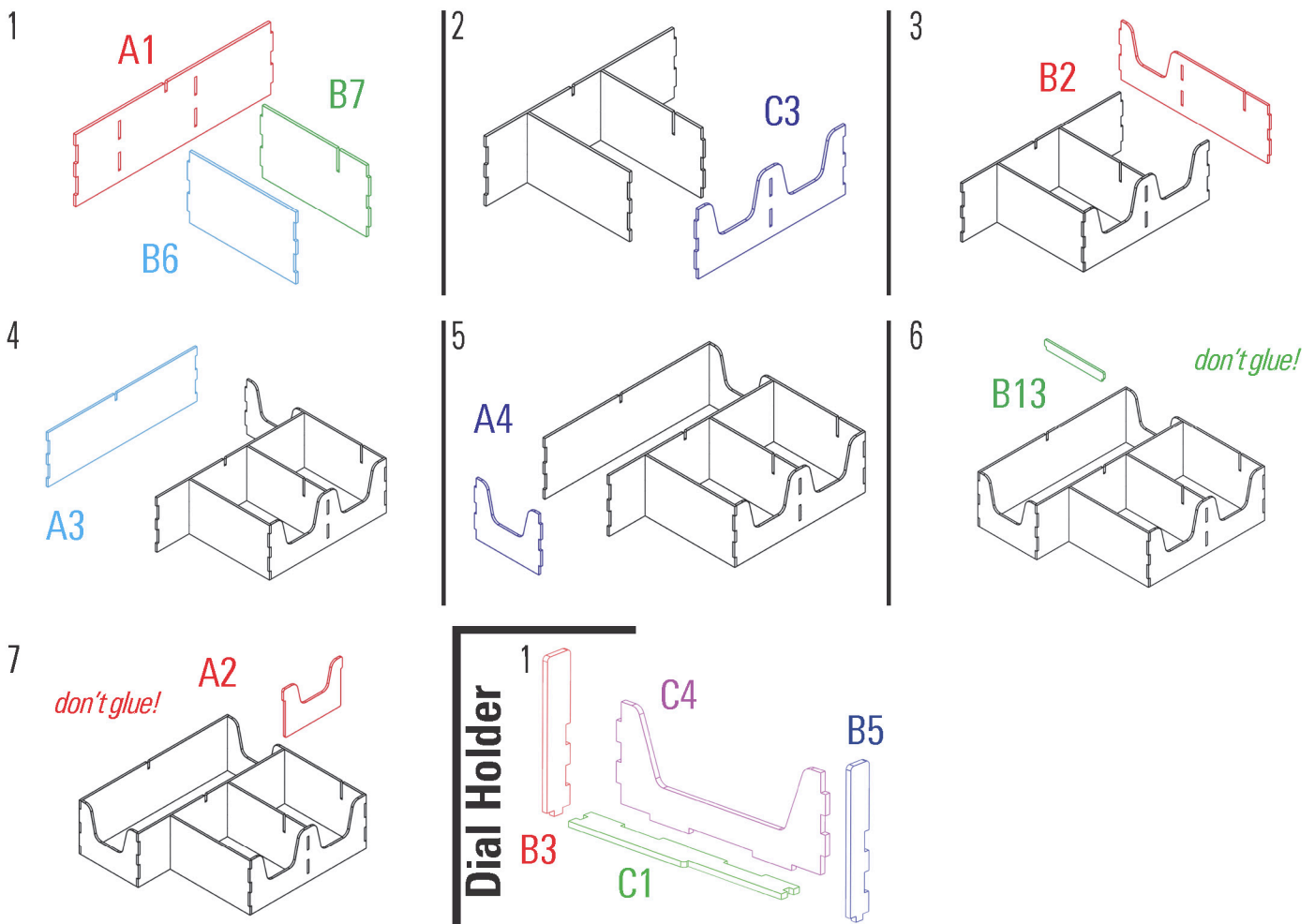

Required parts: **A1, B6, B7, C3, B2, A3, A4, B13, A2**

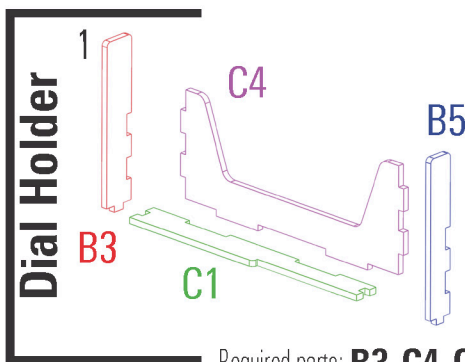

Required parts: **B3, C4, C1, B5**

Token Tray 1

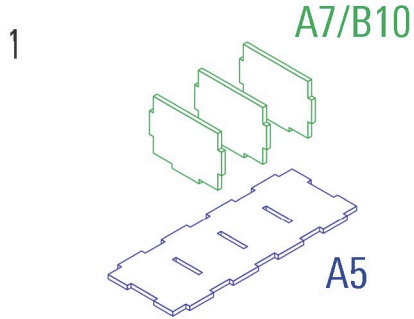

Required parts: **A7**x2, **B10**, **A5**, **C5**x2, **B4**x2

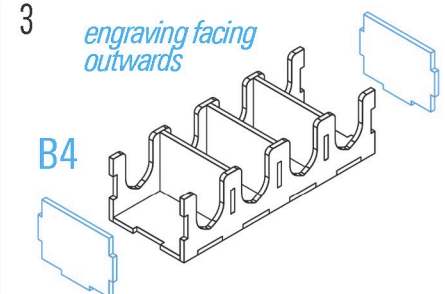
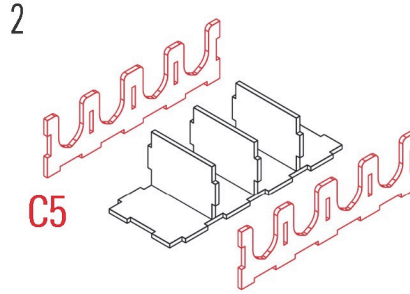

Token Tray 2

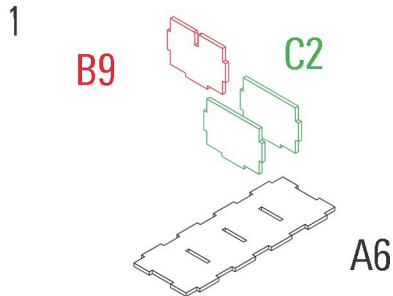

Required parts: **B9**, **C2**x2, **A6**, **B11**, **B12**, **B8**x2, **B1**

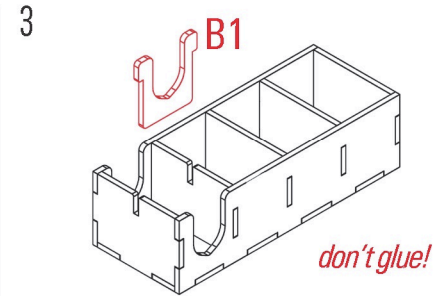
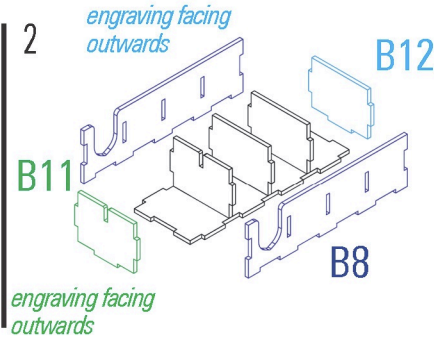

LASEROX

Laserox Design Ltd.
H-2092 Budakeszi
Tiefenweg way 39



Check out our other cool organizers!

ISS Vanguard Organizer

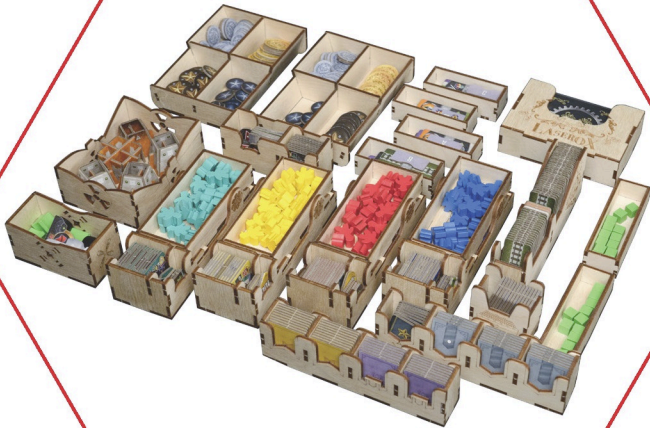

Nucleum Organizer