

# Gambler's Chest

## Compatible with Kingdom Death:Monster Gambler's Chest

This box organizer is compatible with Kingdom Death:Monster Gambler's Chest.

This product is not licensed and is up for change at any time in the future.

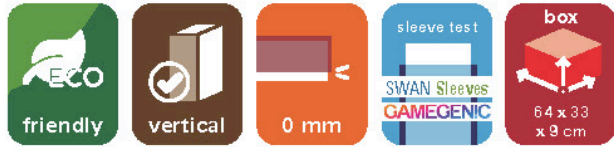
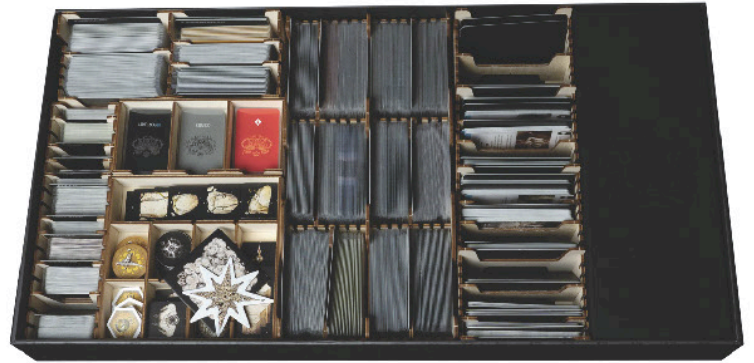

## Assembly Guide



Watch our beginners guide videos on youtube. Just scan the QR code and get started!

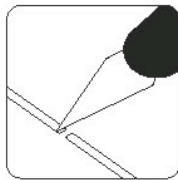

Use an exacto knife to cut the bits connecting the parts to the frame.

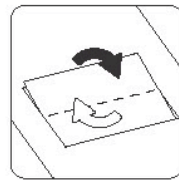

Remove the parts from the frame with a rotating motion along the axis formed by the bits you just cut.



**LASEROX**

Use **wood glue** for assembly. If you encounter any issues, please contact us at [info@laserox.net](mailto:info@laserox.net)

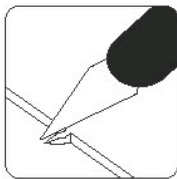

Use the exacto knife to remove any of the remaining connection bits.

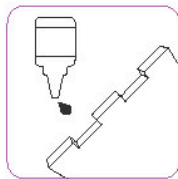

Most joints are press-fit, but some joints might require a drop of glue to ensure a strong bond.

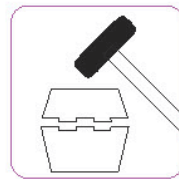

Press the parts together or use a hobby hammer with slight force for assembly.



**WARNING:** Not a toy. Not suitable for children under 14 years of age.

## Box Assembly

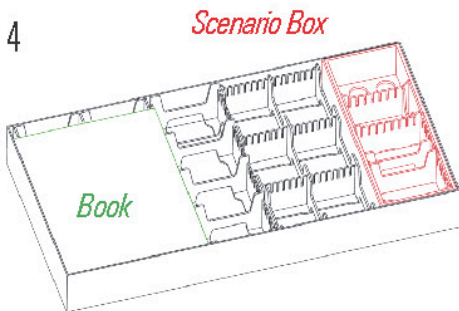
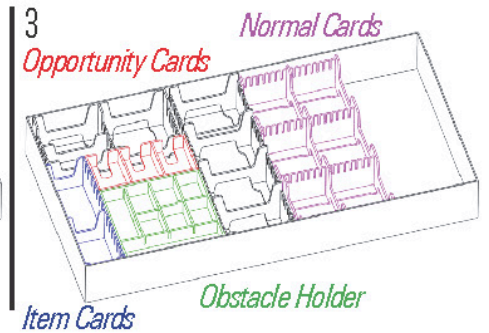
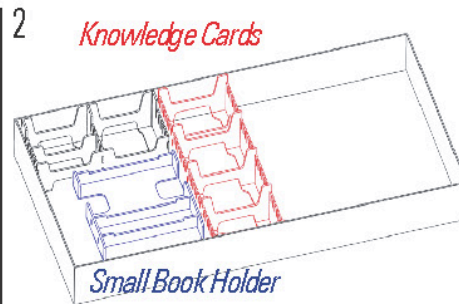
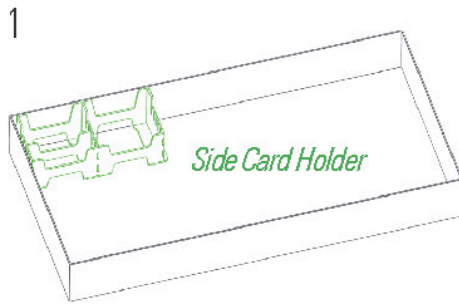

Share your creation!



#laseroxinserts

Watch our "How it fits" video and get your game organized!



<http://tiny.cc/lsrcldmg>

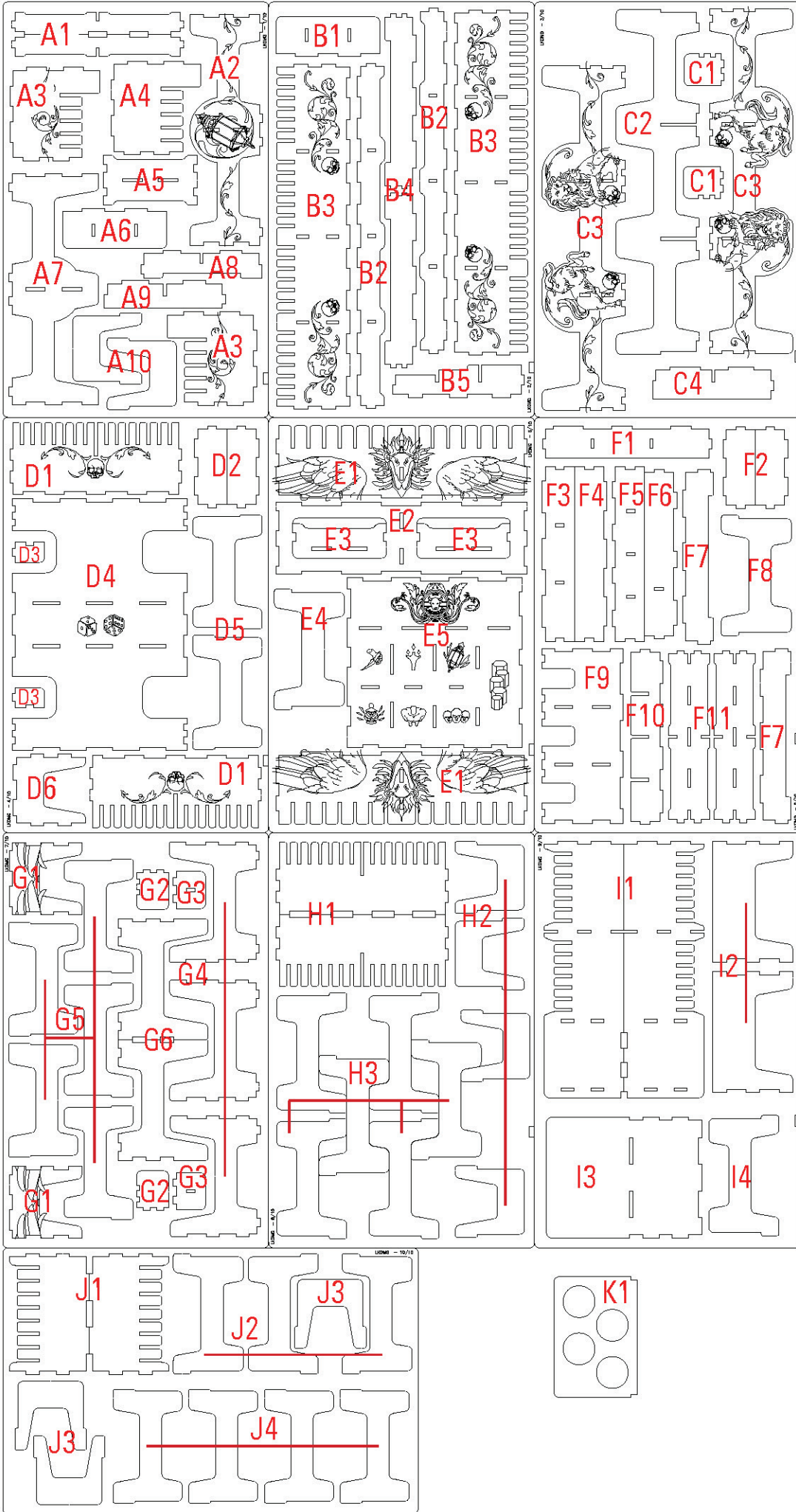

• Some parts might look different than in the assembly instructions, with added decorations/engravings/embellishments.

• Color variations or branch marks are a natural part of the birch plywood.

• The burnt-smell of wood is natural and will dissipate with time.

• Rarely the laser will not cut through the complete sheet, but this can be fixed with the help of a hobby knife. If that is not possible, please contact us for a replacement!

Item Cards

1 D6  
E2

2 G1 E1  
*engraving facing outwards!*

3 H2/A10 *don't glue!*

Required parts: **D6, E2, E1x2, G1x2, H2x4, A10x2**

Knowledge Cards

1 B3 G4  
B3  
*engraving facing outwards!*

2 G6 B2

3 E4/F8/H3 *don't glue!*

Required parts: **B3x2, G4x3, G6x2, B2x2, E4, F8, H3x6**

Obstacle Holder

1 F10 B5  
E5  
*engraving facing upwards!*

2 A8 A9  
C4

3 F6 F5  
F4 F1

Required parts: **F10, B5, E5, A8, A9, C4, F6, F5, F4, F1**

Side Card Holder

1 A7 A4 A3  
A3 A2  
*engraving facing outwards!*

2 E3 A5

3 D5 *don't glue!*

Required parts: **A7, A3x2, A4, A2, E3x2, A5, D5x2**



## Scenario Box

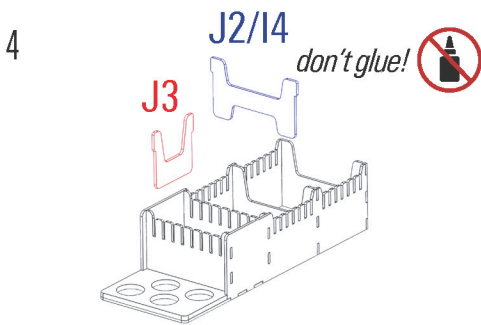
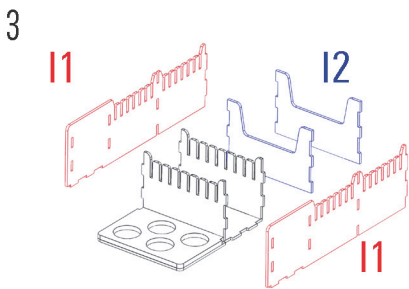
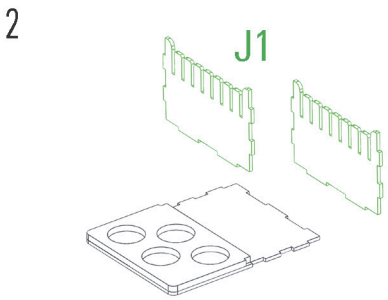
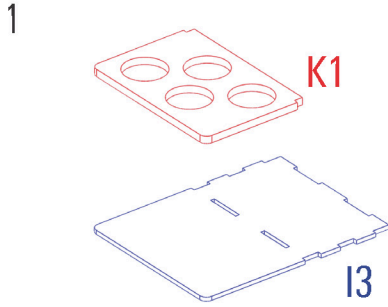

Required parts: **K1, I3, J1x2, I1x2, I2x2, J2x3, I4, J3x3**

## Normal Cards

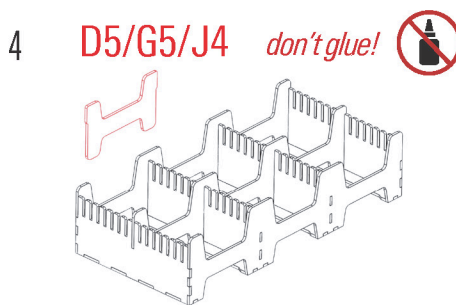
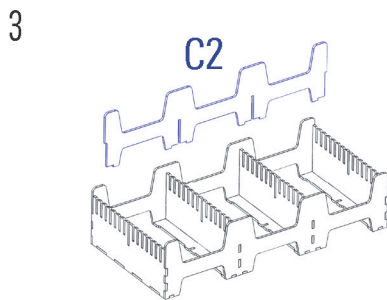
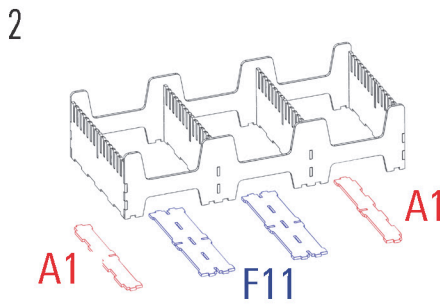
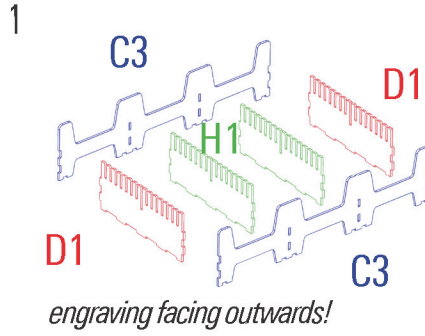

Required parts: **C3x2, D1x2, H1x2, A1x2, F11x2, C2, G5x5, J4x4**

## Small Book Holder

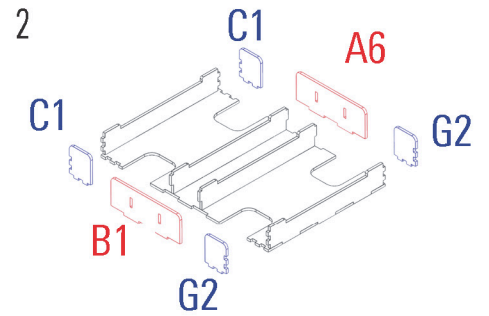
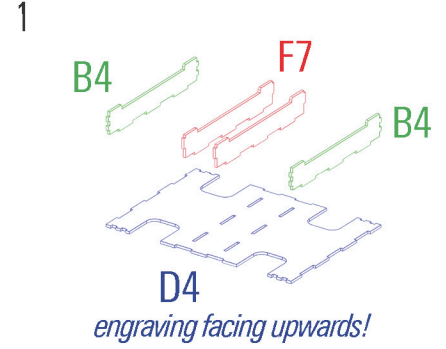

Required parts: **B4x2, F7x2, D4, C1x2, G2x2, A6, B1**

## Opportunity Cards

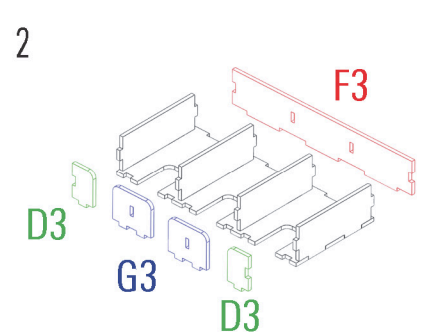
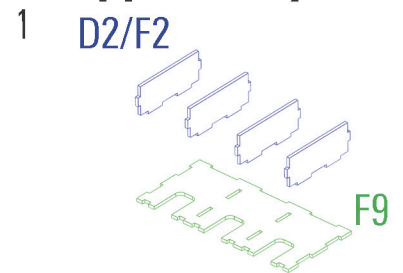

Required parts: **D2x2, F2x2, F9, F3, D3x2, G3x2**