

Galaxy Trucker Upgrade Kit

Compatible with Galaxy Trucker:
Keep on Trucking Expansion®

This is an upgrade kit for Galaxy Trucker organizer.
This kit is licensed by CGE and is up for change at any time in the future.

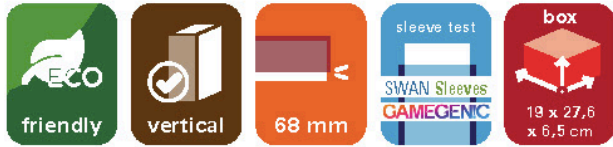

Assembly Guide



Watch our beginners guide videos on youtube. Just scan the QR code and get started!

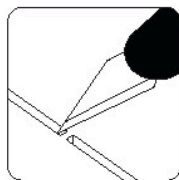

Use an exacto knife to cut the bits connecting the parts to the frame.

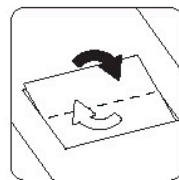

Remove the parts from the frame with a rotating motion along the axis formed by the bits you just cut.



LASEROX

Use **wood glue** for assembly. If you encounter any issues, please contact us at info@laserox.net

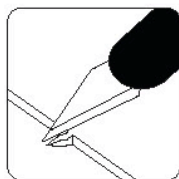

Use the exacto knife to remove any of the remaining connection bits.

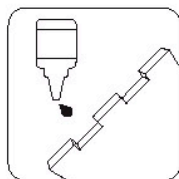

Most joints are press-fit, but some joints might require a drop of glue to ensure a strong bond.

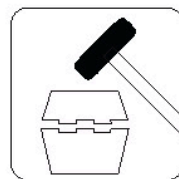

Press the parts together or use a hobby hammer with slight force for assembly.



WARNING: Not a toy. Not suitable for children under 14 years of age.

Box Assembly

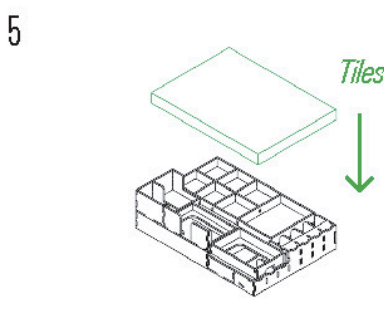
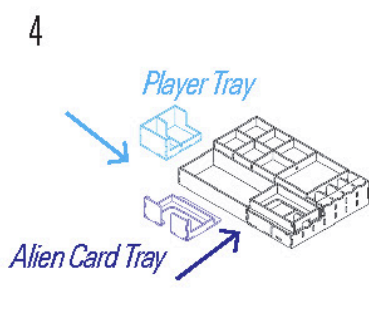
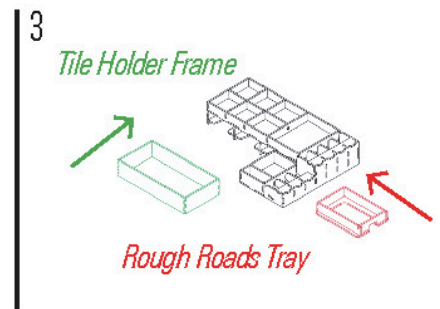
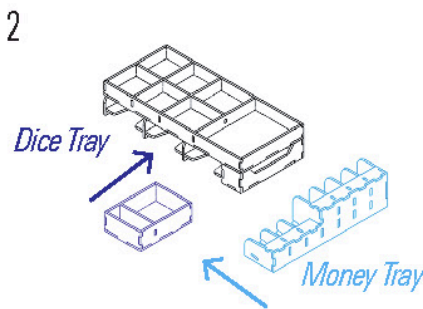
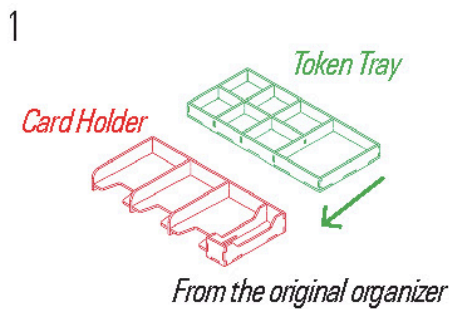

Share your creation!



#laseroxinserts

Watch our "How it fits" video and get your game organized!



<http://tiny.cc/lrxgalaxy>

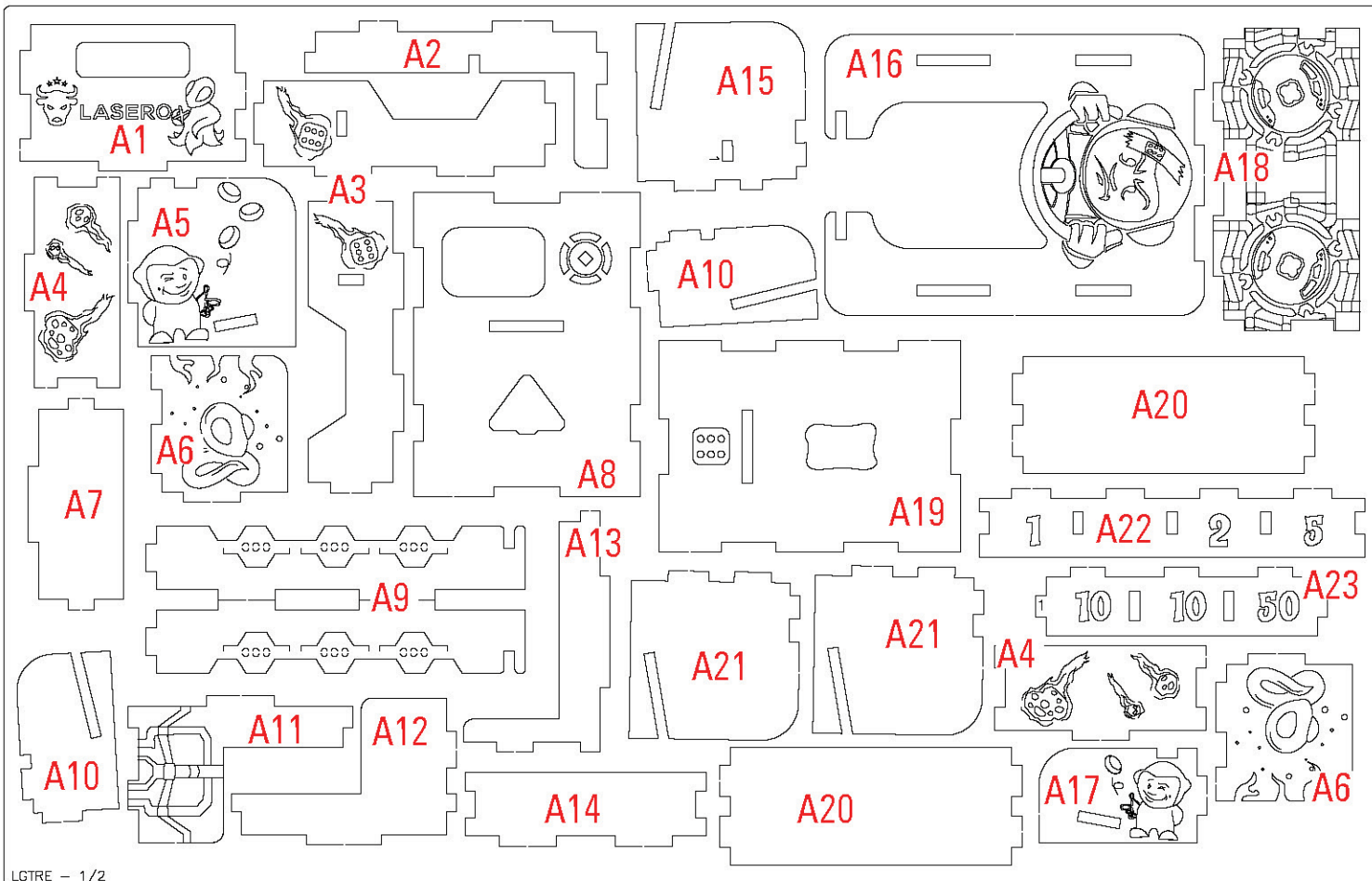

LGTRÉ - 1/2

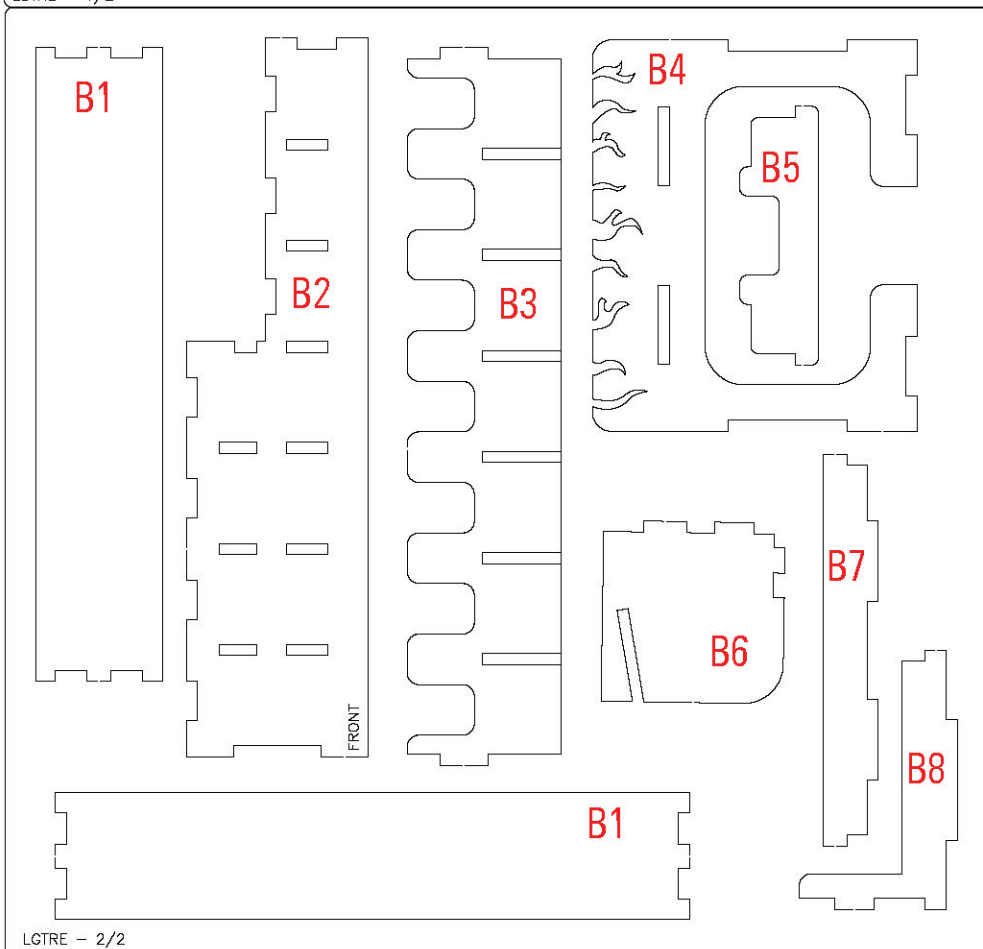

LGTRÉ - 2/2

- Some parts might look different than in the assembly instructions, with added decorations/engravings/embellishments.
- Color variations or branch marks are a natural part of the birch plywood.
- The burnt smell of wood is natural and will dissipate with time.
- Rarely the laser will not cut through the complete sheet, but this can be fixed with the help of a hobby knife. If that is not possible, please contact us for a replacement!

Alien Card Tray

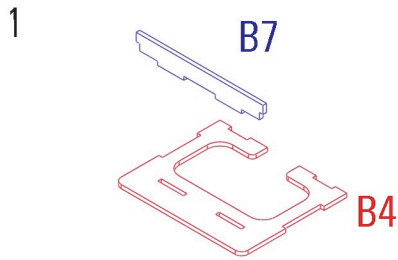

Required parts: **B4, B7, A13, B8, A6x2**

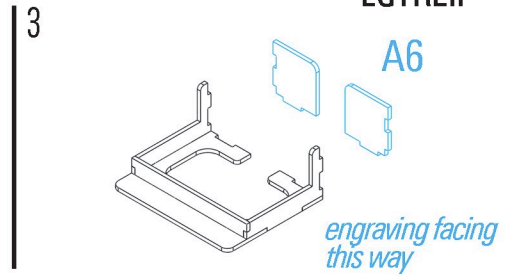
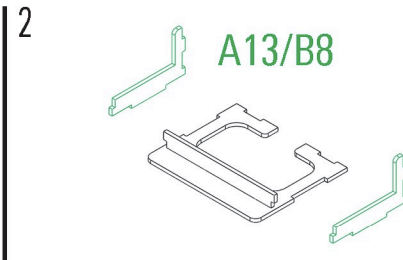

Rough Roads Tray Player Tray

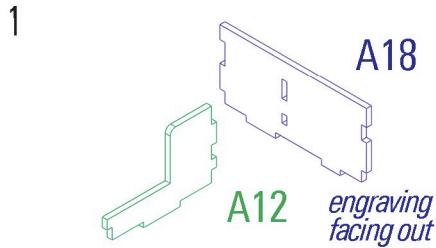

Required parts: **A12, A18, A2, A8, A1, A11**

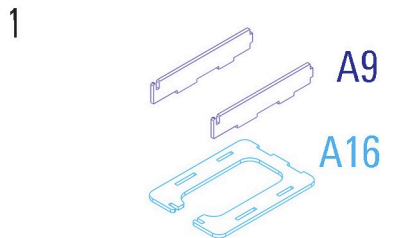
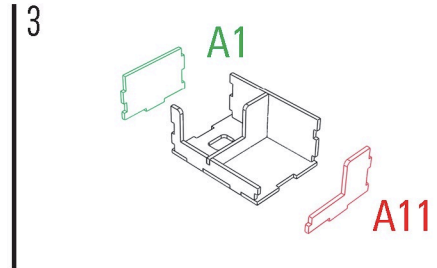
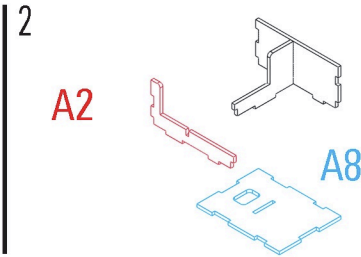

Required parts: **A9x2, A16, A14, B5**

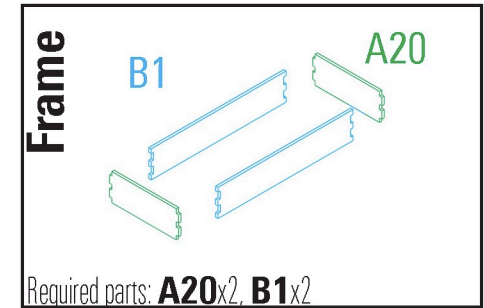
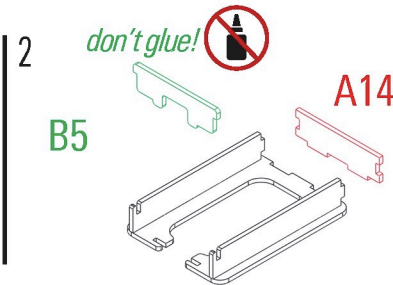

Money Tray

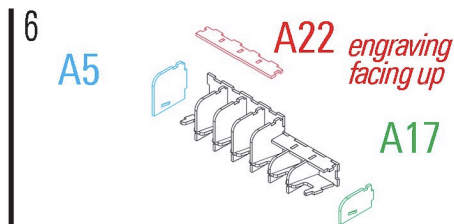
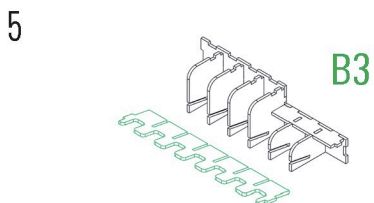
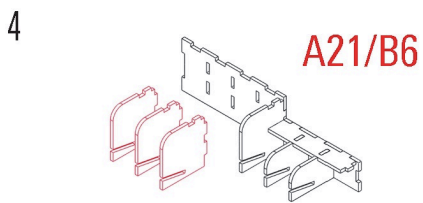
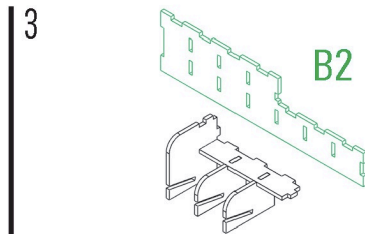
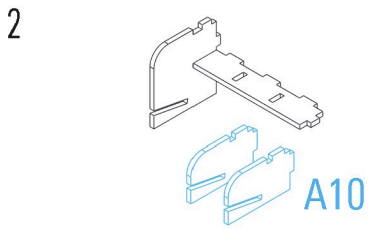
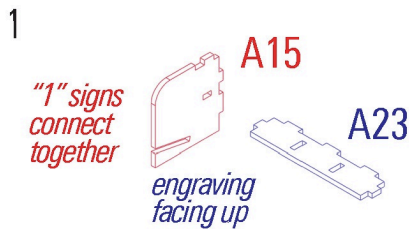

Required parts: **A15, A23, A10x2, B2, A21x2, B6, B3, A5, A17, A22**

Dice Tray

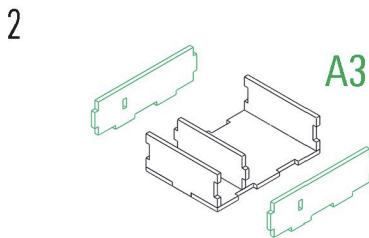
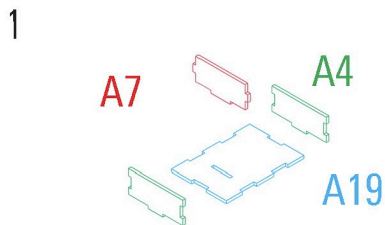

Required parts: **A4x2, A7, A19, A3x2**