

Dueling Wonders

L7WD

Compatible with 7 Wonders Duel



and the following expansions:

7 Wonders Duel: Pantheon

7 Wonders Duel: Agora

This product is not licensed, and is up for change at any time in the future.

Assembly Guide



Watch our beginners guide videos on youtube. Just scan the QR code and get started!

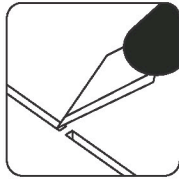

Use an exacto knife to cut the bits connecting the parts to the frame.

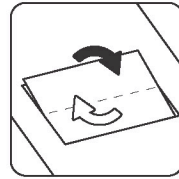

Remove the parts from the frame with a rotating motion along the axis formed by the bits you just cut.

Use **wood glue** for assembly. Always dry fit the parts first to make sure the components are correct ones. If you encounter any issues, please contact us at info@laserox.net or our Facebook page at facebook.com/laseroxinserts.



Use the exacto knife to remove any of the remaining connection bits.

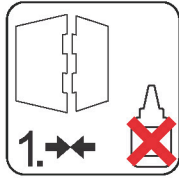

Always dry-fit the parts to together without any glue to make sure you are assembling the correct parts.

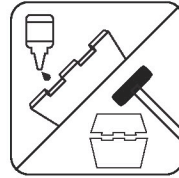

Use a drop of glue along the joints and press the parts together or use a hobby hammer with slight force for assembly.



WARNING Choking hazard!
Not for children under 3 years.

Part numbers

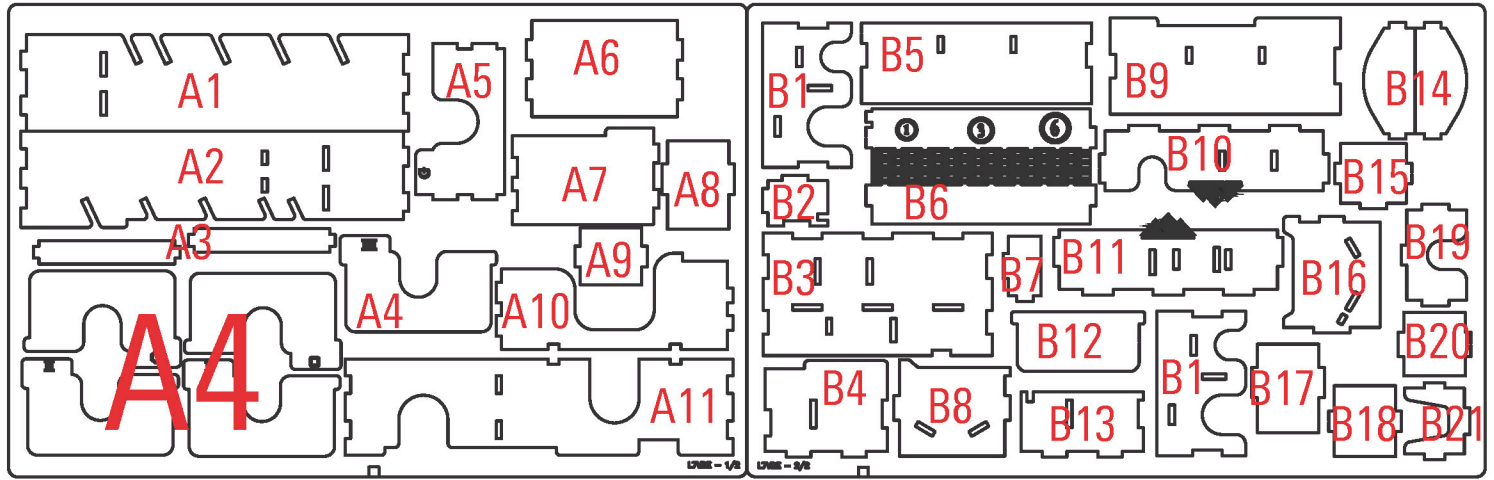

Coins

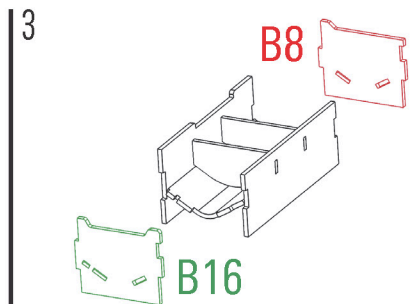
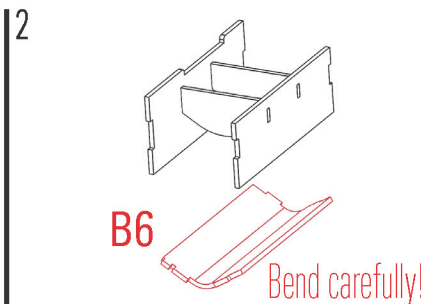
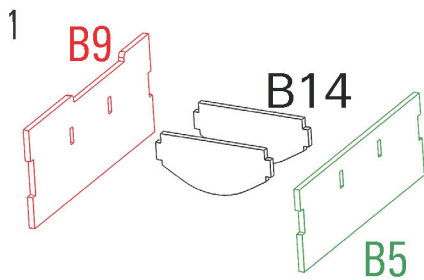

Required parts: **B5, B6, B8, B9, B14x2, B16**

Tiles

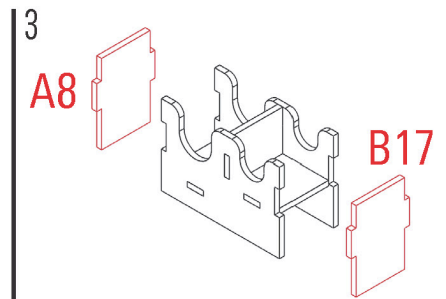
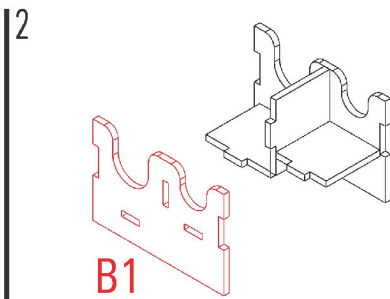
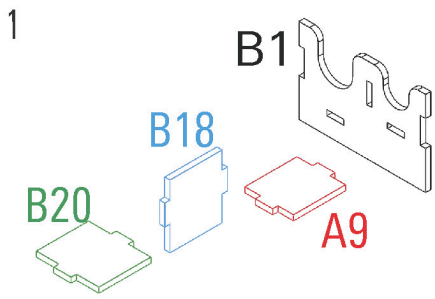

Required parts: **A8,A9,B1x2,B17,B18,B20**

Tokens

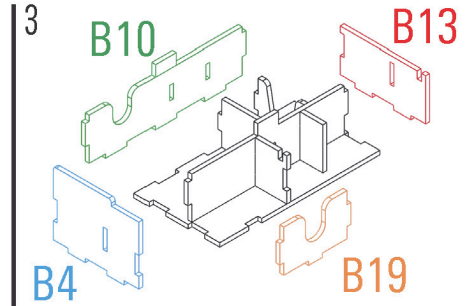
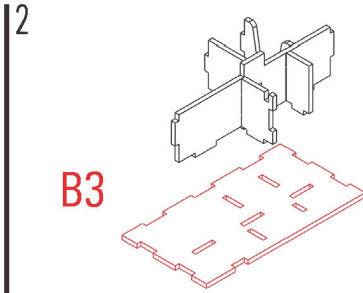
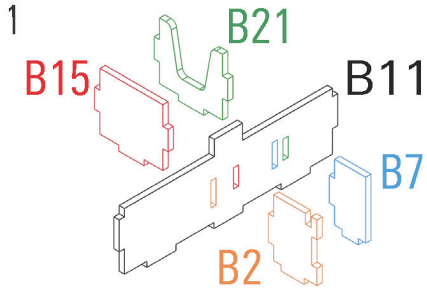

Required parts: **B2,B3,B4,B7,B10,B11,B12,B13,B15,B19,B21**

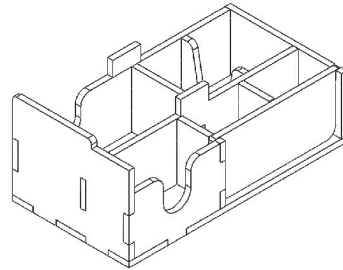
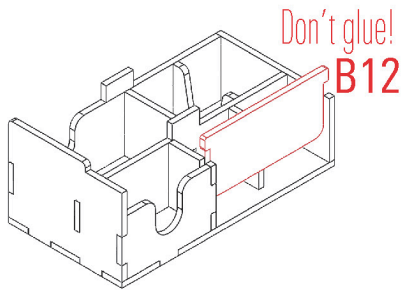

Assembly

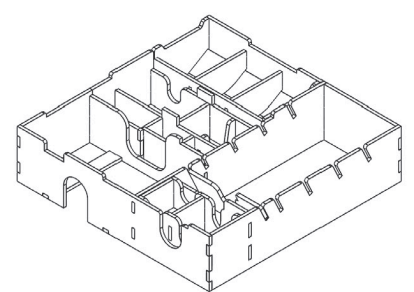
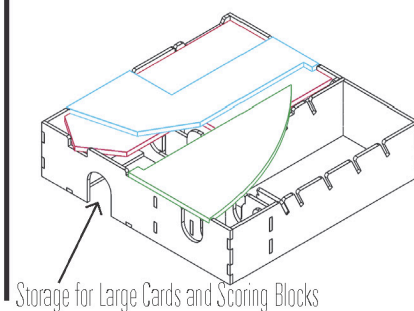
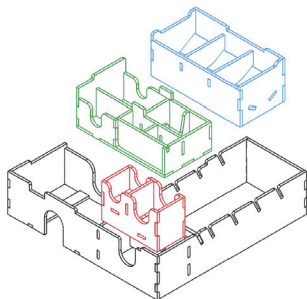
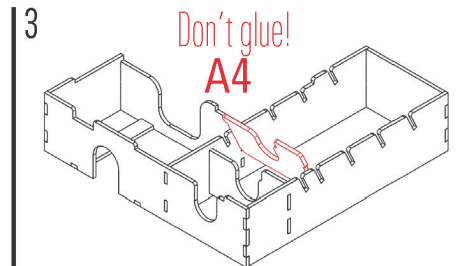
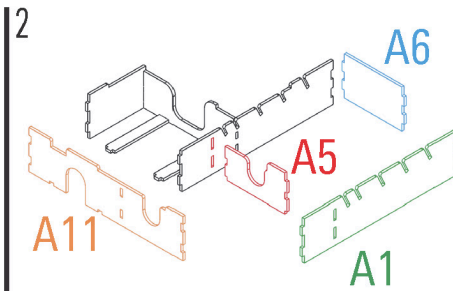
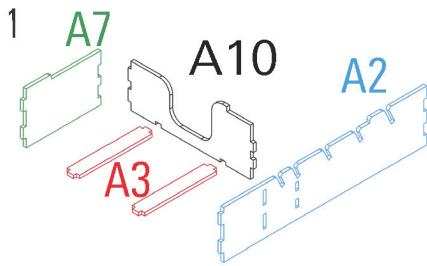

Required parts: **A1,A2,A3x2,A4x5,A5,A6,A7,A10,A11**